



TAC Xenta 711/731

Web Server and Controller

The TAC Xenta 711/731 is a multifunctional presentation and control system with an embedded web server that allows you to access your control application and control networks via a web browser anywhere in the world, anytime.

The Xenta 711/731 series is the first building automation controller to combine building control, web functionality, alarm handling and amazing graphics in a powerful compact package.

Explore the Xenta 711/731 web site with the web browser, check and acknowledge alarms from the LonWorks network or change setpoints or operating conditions. Time schedules and trend logs are easily accessed. The web pages are based on standard Internet technology such as HTML and Java applets. Alarms can be forwarded as e-mails.

This all-in-one solution has everything you need to monitor and control your settings in a single economical device. Furthermore, as Xenta Servers they can be connected via TCP/IP to TAC Vista in larger installations where they can aggregate data for easy operation and benchmarking. Up to 1000 Xenta 711s and/or Xenta 731s can be connected to a TAC Vista Server.

The Xenta 711 supports up to 10 Xenta 400 I/O modules and 30 Xenta 280/300/401 on the LonWorks network while the Xenta 731 supports up to 20 Xenta 400 I/O modules and 30 Xenta 280/300/401 modules. The Xenta 731 also supports Modbus, I/NET and MicroNet.

The Xenta 711/731 web server and controller is equipped with a help function that facilitates daily operation.

The TAC Xenta 711/731 can also communicate with Modbus devices.

TECHNICAL DATA

Supply voltage 24 V AC $\pm 20\%$, 50/60 Hz or 19–40 V DC

Power consumption max. 5 W

Transformer sizing 5 VA

Ambient Temperature

Storage $-20\text{ }^{\circ}\text{C}$ to $+50\text{ }^{\circ}\text{C}$ ($-4\text{ }^{\circ}\text{F}$ to $+122\text{ }^{\circ}\text{F}$)

Operation $\pm 0\text{ }^{\circ}\text{C}$ to $+50\text{ }^{\circ}\text{C}$ ($+32\text{ }^{\circ}\text{F}$ to $+122\text{ }^{\circ}\text{F}$)

Humidity max. 90% RH non-condensing

Mechanical

Enclosure ABS/PC

Enclosure rating IP 20

Flammability class, materials UL 94 V-0

Dimensions see Figure 1

Weight 0.2 kg (0.44 lb)

Real Time Clock

Accuracy at $+25\text{ }^{\circ}\text{C}$ ± 12 minutes per year

Power failure protection 72 h

Communication

A: RS232 2400–57600 bps, RJ45, 8-p

A: RS485 2400–57600 bps, async. terminal block

B: RS232 RJ10, 4-p

C: RS485 sync. (SDLC) terminal block

LonWorks TP/FT-10, terminal block

Ethernet TCP/IP, 10Base-T, RJ45

Agency Compliances

Emission: CE EN 61000-6-3

C-tick C-Tick N1831

FCC FCC Part 15, Subpart B, Class B

Immunity:

CE EN 61000-6-2

Safety:

CE EN 61010-1

UL 916 C-UL US Listed

RoHS directive 2002/95/EG

Part Numbers

Electronics part TAC Xenta 711 007301550

Electronics part TAC Xenta 731 007301650

Terminal part TAC Xenta 400 007309020

TAC Xenta: PC to Serial Kit 007309170

TAC Xenta: Serial Link Kit 007309180

TAC Xenta: General Serial Kit 007309190

TAC Xenta: Programming Serial Kit 007309200

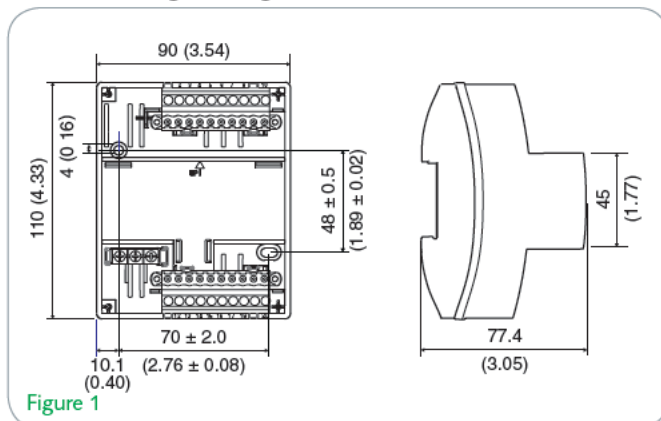

Figure 1

WEB PRESENTATION

The web pages based on HTML in the Xenta 711/731 are used for presentation of status, trends, graphics, alarms, and events. The programming tool, TAC XBuilder, is used for designing, generating and maintaining the pages.

TAC XBuilder is also used for defining and configuring the network variables used for trend logs, alarm objects and event logging.

Status Viewer

The status viewer displays dynamic data such as setpoints, process values and parameters, in an easy to understand table view (fig. 2). An authorized user can set values in the status viewer.

Trend Viewer

The trend viewer displays a graphical line or bar presentation of historical logged and real time data (fig. 3).

The log can be activated either manually or automatically with a condition and/or a starting time.

If energy meters are logged, meter exchanges are handled manually.

Graphics Viewer

The graphics viewer displays graphical presentations of the site or the installation, used for swift and easy monitoring.

In the graphics viewer operating values are dynamically updated and current alarm status is shown (fig. 4). An authorized user can change values in the Graphics Viewer.

Alarm Viewer

The alarm viewer displays information about alarms from the alarm objects (fig. 5). The operator can read, acknowledge, block, filter and sort the alarms in the alarm viewer.

Event Viewer

In the event viewer the type of event, date/time and operator are logged (fig. 6). New events are automatically registered in the event list. When the list is full the oldest event is overwritten. The operator can filter and sort the events in the event viewer.

Time Object Editor

The time object editor displays configuration of time objects (fig. 7). The time object editor makes it possible to edit or create new schedules.

Application Program Viewer

A graphic representation of the application code is displayed in the application program viewer (fig. 8). Function blocks and signals are displayed including dynamic indication of their state or value as the execution proceeds. Static parts, like text and comments are also displayed.

Configuration Web

Xenta 711/731 uses a web interface to configure network, time, servers and ports among others.

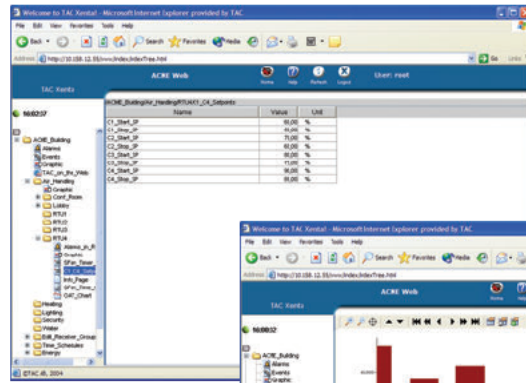

Figure 2

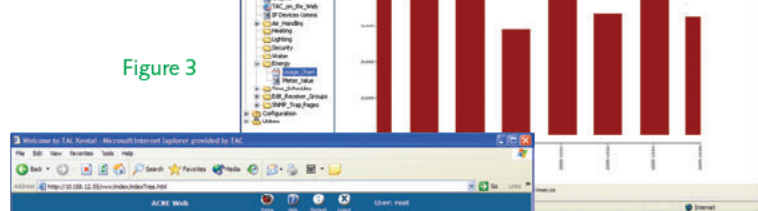

Figure 3

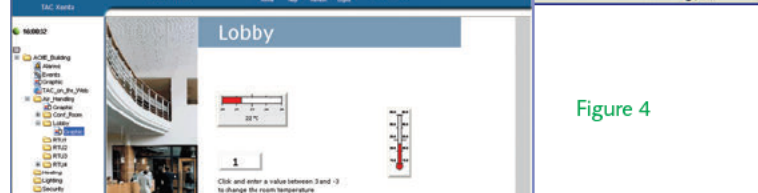

Figure 4

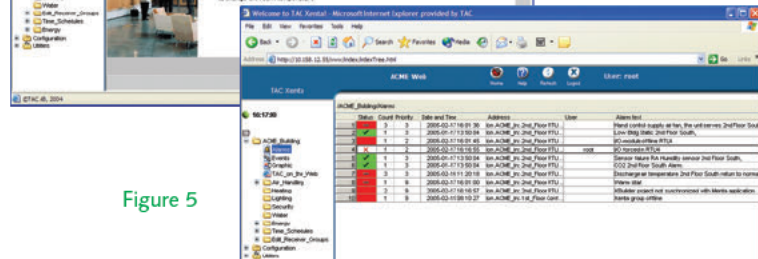

Figure 5

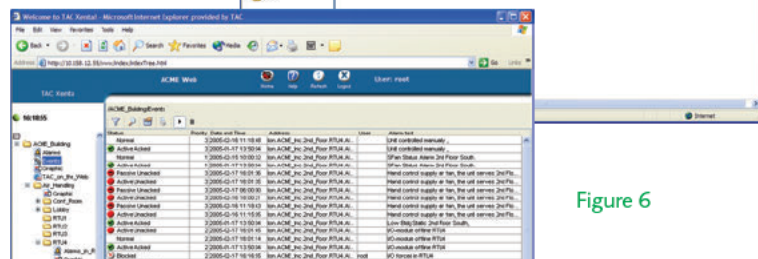

Figure 6

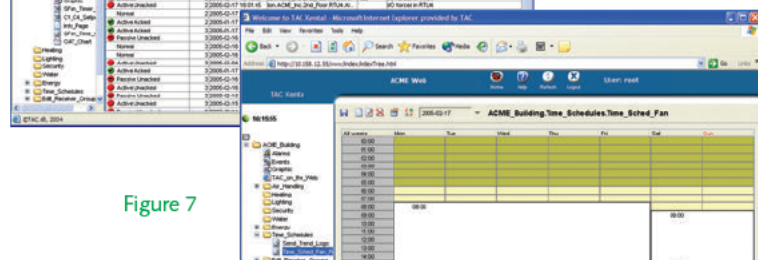

Figure 7

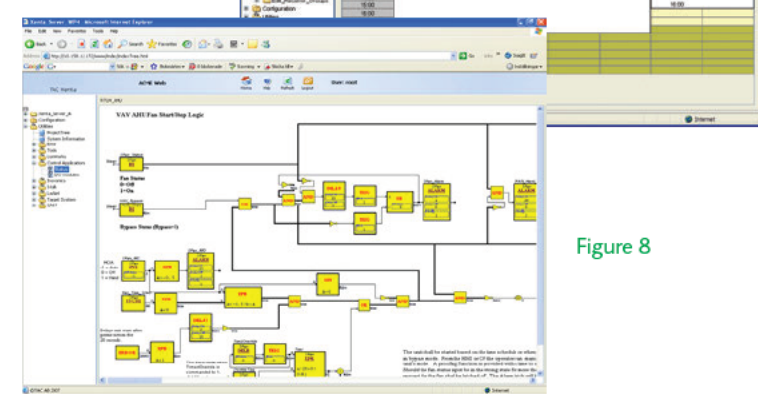

Figure 8

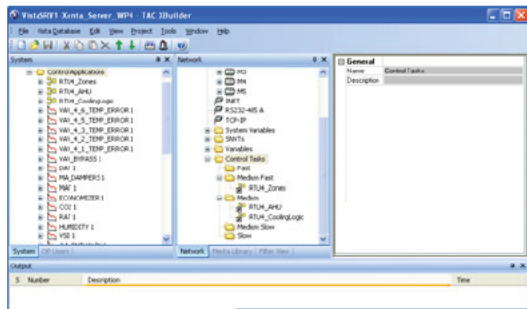

Figure 9

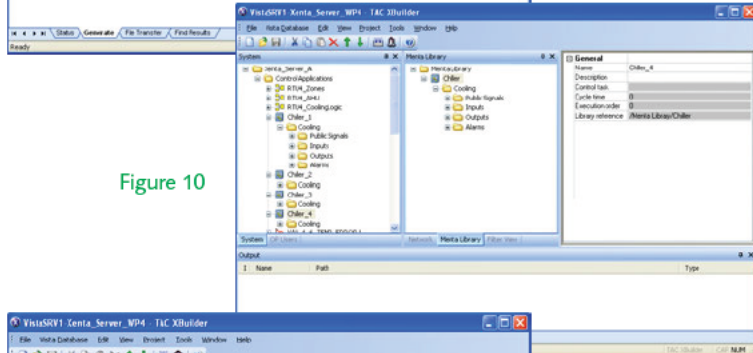

Figure 10

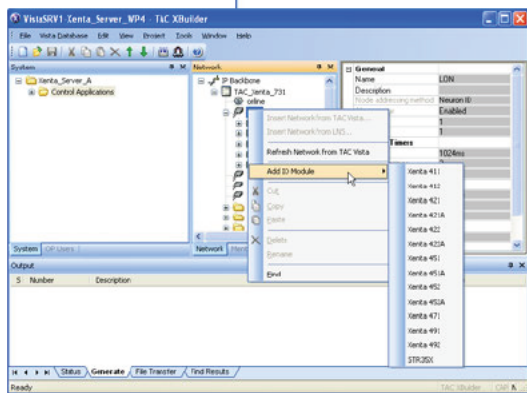

Figure 11

CONTROL APPLICATION

The control applications in the Xenta 711/731 are created by using the programming tools TAC XBuilder and TAC Menta in combination.

The powerful high performance application engine in the Xenta 711/731 can handle a large number of concurrent control applications with different cycle times.

Demanding applications such as lighting control can be handled thanks to the availability of short cycle times (100 ms) (fig 9).

The engineering of a control application is easy and efficient as it uses multiple instances of an application (fig. 10).

The re-use of existing Menta applications, made for Xenta 280/ 300/401, is supported by importing and converting them to fit the Xenta 711/731.

The online debugging of the control application over the Internet is easily accomplished using the easily accessible function block diagrams for all Menta applications in the Xenta 711/731.

An application can be downloaded to the Xenta 711/731 without interfering with the other applications. Restarting the device is not necessary.

The complete range of Xenta 400 I/O modules are supported and configured in TAC XBuilder (fig. 11).

OPERATOR PANEL OP7

OP7 is connected to Xenta 711/731 by use of the OP7 Power adapter. The content of OP7 is created in XBuilder, either automatically or manually configured. A user with the sufficient access rights can use OP7 to

- Monitor and modify values
- View and modify schedules
- View and acknowledge alarms
- View trend logs

SYSTEM ARCHITECTURE

The web presentation of events and status from the controller and LonWorks network is reached through Ethernet or the RS232 A port (fig. 12).

The Xenta 711/731 is one of the nodes in the LonWorks network. A binding tool, for example LonMaker, can be used for installing the Xenta 711/731 in the network. When using TAC Vista no binding tool is needed.

Xenta 711/731 communicates via SNVT or TAC proprietary protocol with the rest of the LonWorks nodes.

A modem can be connected to the Xenta 711/731 using the RS232/RS485 A port. Furthermore a Modbus network, MicroNet network (A port) or I/NET network (C port) can be connected to Xenta 731.

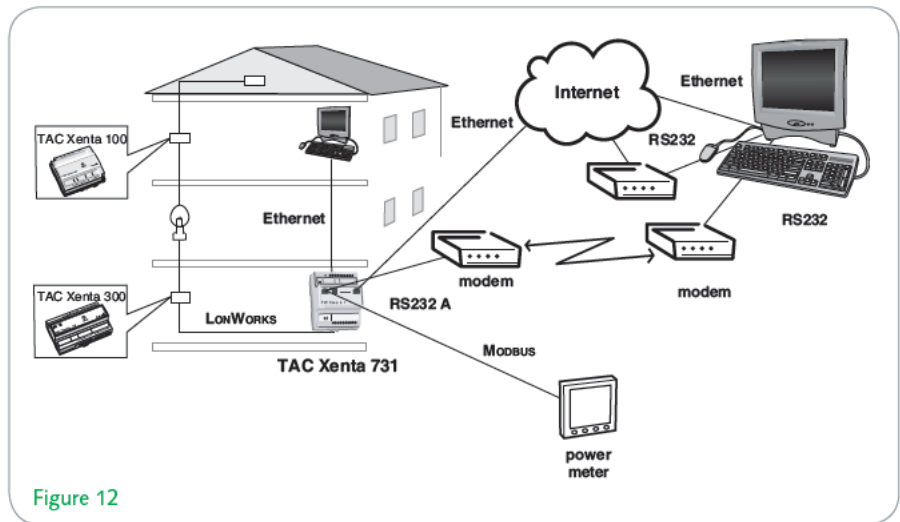

Figure 12

SERVER FUNCTIONS

Web Server

The web server in the Xenta 711/731 is used for configuration and presentation of data from the units in the LonWorks network. The web server supports HTTP version 1.0.

Trend Log

The capacity for trend logging objects is a maximum of 300 objects for each Xenta 711/731. Up to 200,000 values can be logged.

Alarm Handling

The Xenta 711/731 can supervise 300 internal alarm objects and, at the same time, 1,400 alarm objects from the LonWorks network.

The signals can be both digital and analog.

Time Schedules

The Xenta 711/731 can handle 50 time objects with 50 week and 50 holiday schedules in each.

Modem

The serial channel port RS232 A in Xenta 711/731 supports modem signals.

Xenta 711/731 has both dial-up and dial-in capability and alarms can be sent as e-mail.

Xenta 711/731 supports PAP and CHAP authentication.

File Server

An FTP (File Transfer Protocol) server in the Xenta 711/731 makes file transfer possible.

Time Synchronization

The Xenta 711/731 internal time can be synchronized with an external Time Server using NTP (Network Time Protocol) or with another Xenta 711/731, using SNTP (Simple NTP).

Moreover, the Xenta 711/731 can synchronize the time in local LonWorks

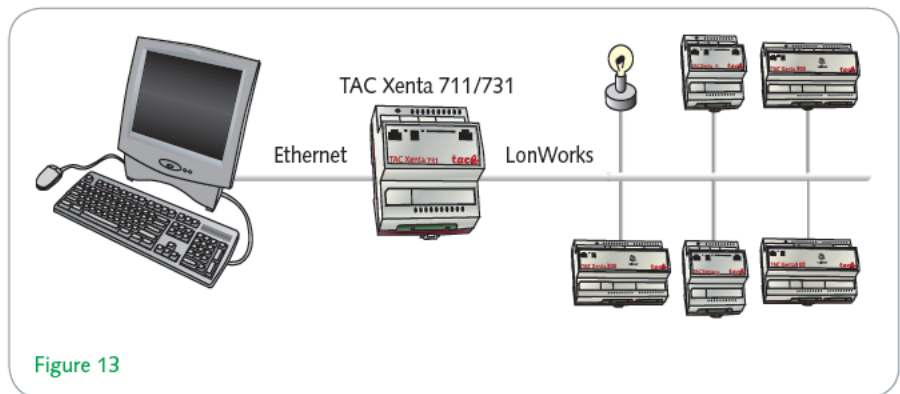

Figure 13

networks with Xenta 30x/4xx units.

Security

The Xenta 711/731 is provided with mechanisms to guarantee a high level of security.

A large number of users may use the Xenta 711/731, each with his or hers individually tailored access authority.

The unit is protected against both unauthorized access and incorrect operation.

A login procedure will give the user access only to those functions he or she is authorized to see and use.

User accounts and access rights can be administered via the web interface.

The security mechanism is based on HTTPS and the use of 128 bit encryption keys. This level of security is considered to be very high and is used by many international banks and e-commerce sites.

The Xenta 711/731 uses a secure interface for configuration with user name and password logon.

The Xenta 711/731 supports configurable I/P level encryption and I/P level filtering when being used in a security network.

SNMP

The Xenta 711/731 can communicate using Simple Network Management Pro-

ocol (SNMP) which allows the exchange of management information between network devices. It is part of the TCP/IP protocol suite.

CLIENT COMPUTER

Web Browser

Xenta 711/731 is optimized for Microsoft Internet Explorer version 6.0 or later.

Java Virtual Machine

Support for Java applets might not be available in all web browsers. If so, a Java plug-in must be installed, otherwise the web pages based on Java applets can not be used.

Java plug-ins for download are found at Sun Microsystems site for Java technology at <http://java.sun.com>.

PC Hardware Requirements

Internal memory min. 128 MB, 512 MB recommended.

AVAILABLE NETWORKS

LonWorks

The Xenta 711/731 is a web based controller and presentation system for LonWorks networks. Using a standard web browser, the operator can easily view and control the applications and the devices in the LonWorks network via Internet or a local intranet.

One Xenta 711/731 can present a LonWorks network or be one of several local presentation devices in a larger network.

Explore the Xenta 711/731 web site with the web browser, check and acknowledge alarms from the LonWorks network or change setpoints or operating conditions. Time schedules and trend logs are also easily accessed. The web pages are based on standard Internet technology as HTML and Java applets. Alarms can be forwarded as e-mails.

The Xenta 731 can also act as a Xenta server for Lonworks and has in-built connectivity to Vista. This option provides an unsurpassed and integrated solution for building management and security.

The Xenta 711/731 has the capacity to supervise a LonWorks network with approximately 30 nodes. The amount of SNVTs possible to bind to each unit is about 400. Both polled and bound SNVTs can be monitored.

Modbus Communication

(Xenta 731 only)

The Xenta 731 can exchange data with devices on networks other than the LonWorks network. By using the serial interfaces RS232 or RS485, the Xenta 731 can be configured for communication using a serial protocol such as Modbus.

The Xenta 731 can also communicate by using the 10Base-T port on the front to communicate over the Ethernet network, such as Modbus TCP. Use TAC XBuilder to set up the port you want to use.

Device Editor: Is used to configure the communication protocol for Xenta 731.

A device template is created for every type of device that the Xenta 731 communicates with.

The device editor is included in the TAC XBuilder installation.

Device Limitations: When using the Modbus protocol, the Xenta 731 interface can communicate with a maximum number of devices as follows: as a Modbus Master: 31 Modbus Slaves, as a Modbus Slave: 1 Modbus Master, and Modbus TCP: 100.

I/NET

(Xenta 731 only)

The Xenta 731 is a multifunctional control and presentation system with a built-in (embedded) web server. It offers I/NET users a feature rich web solution by providing secure web browser access to controllers and networks.

Monitoring, energy management, alarm annunciation, logging, scheduling and point overrides are all accessible via an easy to use and intuitive graphical user interface.

TAC XBuilder programming tools enable speedy configuration and engineering.

The full range of I/NET controllers are supported.

I/NET is an easy-to-use, scalable and modular securing and building automation system for the control of HVAC plant and associated building services. It offers unique benefits for small to medium sized buildings and complexes.

The physical size of the connected I/NET system is a factor in this but is not a primary limitation.

In some systems therefore more than one Xenta 731 may be required to handle the total system traffic.

The Xenta 731 *web server* has been tested with up to 1,000 TAC Vista Security points.

MicroNet

(Xenta 731 only)

The Xenta 731 is a multifunctional control and presentation system with a built-in (embedded) web server. It offers MicroNet and Satchnet users a feature rich web solution by providing secure web browser access to MicroNet and Satchnet controllers and networks.

Monitoring, energy management, alarm annunciation, logging, scheduling and point overrides are all accessible via an easy to use and intuitive graphical user interface.

VisiSat and TAC XBuilder programming tools enable speedy configuration and engineering.

The full range of MicroNet and Satchnet controllers and Bus du jour networking options are supported.

MicroNet is an easy-to-use, scalable and modular building automation system for the control of HVAC plant and associated building services. It offers unique benefits for small to medium sized buildings and complexes.

MicroNet users can choose the communications platform best suited to their business: NCP, ARCNET or LonWorks.

ACCESSORIES

Serial Communication

For installing the Xenta 711/731, cable kit 007309200 is needed, ordered separately.

Modem Connection

For connecting the Xenta 711/731, cable kit 007309160 is needed, ordered separately.

MN-MI Connection

For connecting the Xenta 711/731, cable kit 007309200 is needed, ordered separately.

Cable

The Xenta 711/731 is connected to the Ethernet network with a standard UTP-cable or a standard STP-cable. For more information see TAC Xenta 500/700/555/911/913, Handbook.

CABLES

- G and G0: Min. cross-sectional area 0.75 mm² (AWG-19).
- C1 and C2: Xenta 711/731 communicates on a joint network, LonWorks TP/FT-10, 78 kbps.
- Xenta 731: Belden 9502 for MicroNet MN50 Series.
- Xenta 731: Belden 8762 for other MicroNet controllers.

OP7

Operator panel for Xenta 711/731 See the OP7 data sheet (03-00072) for details.

DESIGN AND MOUNTING

The Xenta 711/731 is designed around a microprocessor.

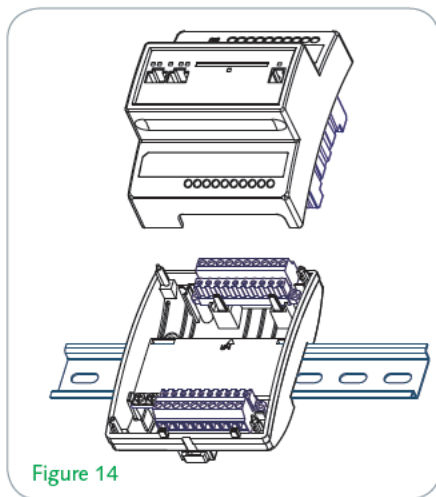

Figure 14

The device consists of two parts, a terminal including the terminal block, and the electronics with the circuit boards and contacts (fig. 14).

Power Failure Protection

Settings, like configuration and web pages, are stored in the non-volatile (flash) memory and will not be lost after a power outage.

Real Time Clock

The clock provides the internal event log with a time stamp. A built-in capacitor maintains operation of the clock for at least 72 hours in the event of a power failure. This real time clock can be configured to synchronize with the TAC Vista Server and automatically adjust for day light saving changes.

Mounting

The Xenta 711/731 is cabinet mounted on a TS 35 mm norm rail EN 50022.

To simplify installation, the terminal can be pre-mounted in the cabinet, (fig. 14).

If the Xenta 711/731 is to be wall mounted, a wide range of standardized boxes are available.

INSTALLATION/CONNECTION

Modular jacks

- RS232 A: Modem connection. Connection using hardware signals for modem communication.
- RS232 A: MN-MI connection for ARC-NET (MN-MI is mandatory)
- RS232 B: PC ("Console") connection. Connection using basic signals, primarily intended for a PC during configuration.
- 10Base-T: Connection for a LAN (Ethernet) cable and commissioning.

LEDs

A number of light-emitting diodes in the electronics part of the Xenta 711/731 indicate that the application program is running and when communication is in progress.

"Reset Button"

Shorting terminals 9 and 10 ("Fail-safe") at restart will inhibit programs from hanging and put the internal program in a fail-safe state.

Terminal Connections

There is a label on the front of the module showing both the numbers and the names of the terminals (1 G, 2 G0 and so on). The numbers are also shown in the plastic of the terminal part.

Term.	Term. No.	Description Name
1	G	24 V AC (or DC+)
2	G0	Ground
3	C1	LonWorks TP/FT-10
4	C2	LonWorks TP/FT-10
5	RX/TX+	Xenta 731: RS485 A
6	RX/TX-	Xenta 731: RS485 A
7	RX+	Xenta 731: RS485 A
8	RX-	Xenta 731: RS485 A
9	G0	
10	Fail-safe	
16	G0	Ground
17	G0	Ground
19	RX/TX+	Xenta 731: RS485 C
20	RX/TX-	Xenta 731: RS485 C

MODBUS COMMUNICATION

The TAC Xenta 711/731 can communicate with Modbus devices using:

- Serial interface (RS485 or RS232), as a Master with a maximum of 31 Slaves connected; or as a Slave.
- Modbus TCP through the 10Base-T port, as a Modbus TCP client. A maximum of 100 Modbus TCP Servers can be connected.

Port configuration is done in TAC Xbuilder.

Device Editor

The Device Editor, which is included in the TAC Xbuilder installation, is used to define the data exchange with connected devices. Reusable device templates are created for the device types.